

# **1 Introduction**

## **1.1 Features**

- LCD display 128×32 dot matrix;
- USB communication interface;
- Impact direction automatically identifying;
- Memory 270 average data in 9 files ;
- Upper and lower limit pre-setting;
- Battery capacity display and power off automatically lack of voltage;
- Backlight for convenient use in darkness; Software calibration;
- AAA 1.5V(7#)battery 2 pc;
- Computer software available.

## **1.2 Main application and testing range**

### **1. 2. 1 Main application**

- The installed machinery and permanently assembled parts ;
- Die cavity of moulds;
- Heavy and large work piece;
- Failure analysis of pressure vessel, steam turboset and other equipment;
- Narrow space workpiece;

- Axletree and other spare parts;
- Material identification of the metal material warehouse;
- Quick inspection for large workpiece;
- Others.

### 1. 2. 2 Testing range

See table 1.

Table 1

Material	Hardness scale	Application range
Steel and Cast Steel	HRC	17.9~68.5
	HRB	59.6~99.6
	HRA	59.1~85.8
	HB	104~651
	HV	83~976
	HS	32.2~99.5
Wrought Steel	HB	143-650
Cold Work Tool Steel	HRC	20.4~67.1
	HV	80~898
Stainless Steel	HRB	46.5~101.7

	HB	85~655
	HV	85~802
Grey Cast Iron	HB	93~334
Nodular Cast Iron	HB	131~387
Cast Aluminum Alloys	HB	19~164
	HRB	23.8~84.6
Copper-Zinc Alloys	HB	40~173
	HRB	13.5~95.3
Copper-Aluminum Alloys	HB	60~290
Wrought Copper	HB	45~315

### 1.3 Specification

#### 1.3.1 Standard delivery

TIME®5100 Main Unit	1
AAA 1.5V(7#) battery	2
Small supporting ring	1
Cleaning brush	1
Hardness test block (760±30HLD)	1
USB communication cable	1

Driving disk for computer

1



### 1. 3. 2 Optional parts

DataView for TIME®5100;

Supporting rings, see table 2.

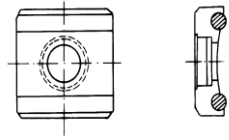
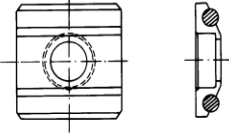
Table 2

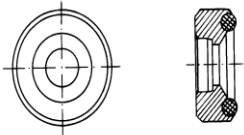
No.	Code	Model	Sketch	Remarks
1	03-03.7	Z10-15		For testing cylindrical outside surface R10-R15
2	03-03.8	Z14.5-30		For testing cylindrical outside surface R14.5-R30
3	03-03.9	Z25-50		For testing cylindrical outside surface R25-R50
4	03-03.10	HZ11-13		For testing cylindrical inside surface R11-R13
5	03-03.11	HZ12.5-17		For testing cylindrical inside surface R12.5-R17
6	03-03.12	HZ16.5-30		For testing cylindrical inside surface R16.5-R30

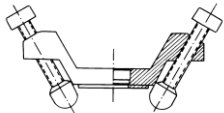
7	03-03.13	K10-15		For testing spherical outside surface SR10-SR15
8	03-03.14	K14.5-30		For testing spherical outside surface SR14.5-SR30
9	03-03.15	HK11-13		For testing spherical inside surface SR11-SR13
10	03-03.16	HK12.5-17		For testing spherical inside surface SR12.5-SR17
11	03-03.17	HK16.5-30		For testing spherical inside surface SR16.5-SR30
12	03-03.18	UN		For testing cylindrical outside Surface, radius adjustable R10~∞

#### 1.4 Working condition

Environmental temperature: 0°C ~ 40°C ;

Relative humidity: ≤ 90 %;

The surrounding environment should be no vibration, strong magnetic field, corrosive medium and heavy dust.

## 2 Structure feature & testing principle

### 2.1 Structure feature

Structure feature see figure 1.

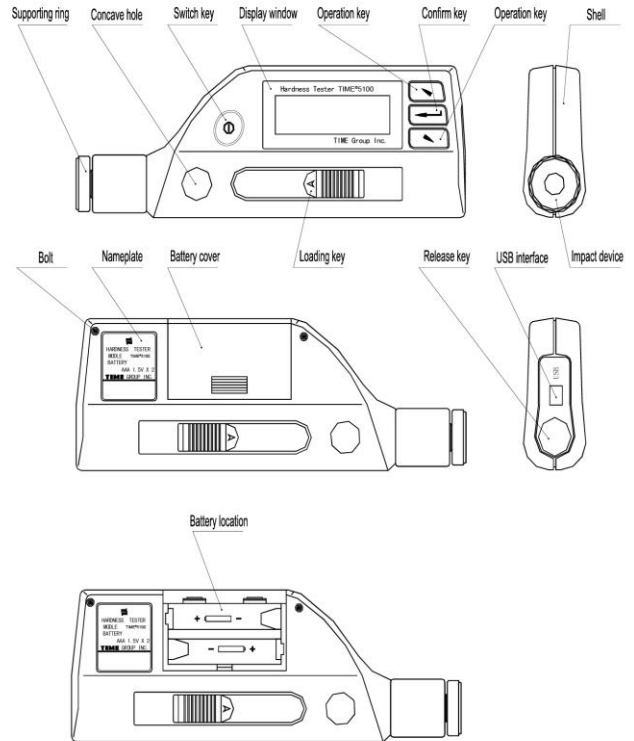

Figure 1

## 2.2 Working principle

The basic principle is: The impact object of certain weight pounds at the testing surface under certain test force. Measure the impacting velocity and the rebounding velocity of the impact object respectively when it is 1mm above the testing surface. The calculation formula is as followed:

$$HL=1000\times VB/VA$$

Where, *HL*--Leeb hardness value

*VB*-- Rebounding velocity of the impact object

*VA* --Impacting velocity of the impact object

## 3 Specialties

### 3.1 Specifications

3.1.1 Impact Device: D;

3.1.2 Features of Impact Device and testing demand see table 3, indentation dimension of test tip see table 4;

Table 3

Parameter	Value
Impact energy	11mJ
Impact object weight	5.5g
Hardness of test tip	$\geq 1600\text{HV}$
Diameter of test tip	3mm
Material of test tip	Tungsten Carbide
Max. hardness of workpiece	940HV
Roughness of workpiece Ra	$\leq 1.6\mu\text{ m}$
Min. weight of workpiece	
Test directly	$>5\text{kg}$
Need stable support	2~5kg
Need couplant	0.05~2kg
Min thickness of workpiece	
Test directly	$>5\text{mm}$
Need couplant	$\leq 5\text{mm}$
Min. depth of harden surface	0.8mm



Table 4

Hardness (HV)	Parameter	Value (mm)
300	Indentation diameter	0.54
	Indentation depth	0.024
600	Indentation diameter	0.54
	Indentation depth	0.017
800	Indentation diameter	0.35
	Indentation depth	0.010

**3.1.3** Accuracy and repeatability of displayed value see table 5.

Table 5

Hardness value of Leeb standard test block	Error of displayed value	Repeatability of displayed value
760 ± 30HLD	± 6 HLD	6 HLD
530 ± 40HLD	± 10 HLD	10 HLD

**3.1.4** Measuring range: 170~960HLD;

**3.1.5** Measuring direction: 360° ;

**3.1.6** Scales: HL、HB、HRB、HRC、HRA、HV、HS;

**3.1.7** Display: 128×32 dot matrix LCD;

**3.1.8** Data memory: 270 average data in 9 files;

**3.1.9** Upper and lower limit setting: same to measuring range;

**3.1.10** Power: AAA (7#) 1.5V 2pc;

**3.1.11** Continual working time : about 150 hours (without backlight);

**3.1.12** Communication interface: USB2.0.

## **3.2 Dimension and weight**

**3.2.1** Dimension:155mm×55mm×25mm

**3.2.2** Weight: about 166g.

## **4 Using**

### **4.1 Preparation before using**

#### **4.1.1Preparation for sample surface**

Preparation for sample surface should conform to the relative requirement in figure 3.

- In the preparation process for sample surface, the hardness effect of being heated or cold processing on the surface of sample should be avoided;
- Too big roughness of the measured surface could cause measure error. So, the measured surface must be metallic luster, smoothing and polish, without oil stain;

- Curved surface: The best testing surface of sample is flat. When the curvature radius  $R$  of the surface to be tested is smaller than 30mm, the small support ring or the shaped support rings should be chosen, see figure 2.

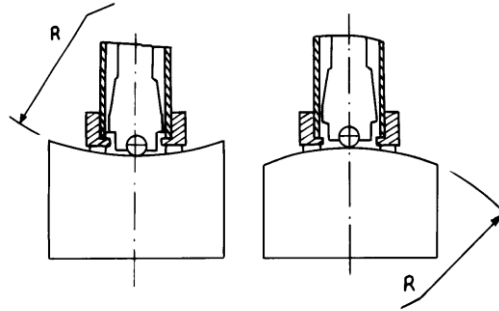

Figure 2

- Support of test sample

Support is not necessary for heavy sample.

Medium-weight parts must be set on the smoothing and stable plane. The sample must set absolutely equability and without any wobble.

- The sample should have enough thickness, minimum thickness of sample should conform to table 3.
- For the sample with hardened layer on surface, the depth of hardened layer should conform to table 3.
- Coupling

Light-weight sample must be firmly coupled with a heavy base plate. Both coupled surfaces must be flat and smooth. And there should be no redundant coupling agent exists. The impact direction must be vertical to the coupled surface.

- When the sample is a big plate, long rod or bending piece, it can be deformed and become unstable, even though its weight and thickness is big enough, and accordingly, the test value may not be accurate. So should be reinforced or supported at its back.

- Magnetism of the sample itself should be avoided.

#### **4.1.2 Preset test parameters**

See 6.8.

### **4.2 Testing**

- The instrument can be calibrated with standard test block, the accuracy and repeatability displayed should be within the regulation of table 5.

#### **4.2.1 Loading**

- Put the supporting ring onto the surface of workpiece, hold the concave area by left hand, and press down the body by right hand while holding the loading key;
- Impact direction should be vertical to tested surface.

#### **4.2.2 Testing**

- Press release button at top of the main unit to test. The sample and the main unit as well as the operator are all required being stable;

- Usually, test 5 times on each measure area of sample. The data dispersion should not be more than mean value  $\pm 15HL$ ;
- The distance between any two indentations or from the center of any indentation to the edge of tested sample should conform to the regulation of table 6;

Table 6

Distance between any two indentations (mm)	Indentation to the edge of tested sample (mm)
$\geq 3$	$\geq 5$

- For special material, if accurate conversion from the Leeb hardness into other hardness method is wanted, contrastive test must be done to get conversion relations. Use inspected qualified Leeb hardness tester and corresponding other hardness tester to test at same sample respectively. For each hardness value, measure 5 Leeb hardness values. using Leeb hardness arithmetic average value and corresponding hardness method average value as correlative value to make individual hardness contrastive curve, see figure 3.

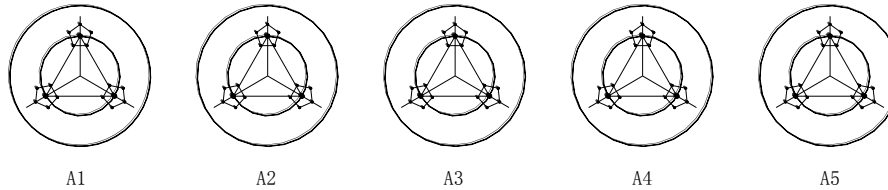

A1-A5: Hardness samples  
 “•” : Impress of hardness scales to be converted  
 “, ” : Impress of HL hardness scales

Figure 3

### 4.2.3 Testing result

- In front of Leeb hardness symbol HL, expresses the hardness value; behind HL expresses type of impact device. For example: 700HLD expresses using D type of impact device measured Leeb hardness value is 700;
- For other hardness method converted from Leeb hardness, put the symbol of corresponding hardness method in front of Leeb hardness symbol. For example: 400HVHLD expresses using D type of impact device measured Leeb hardness value converted Vickers hardness value is 400.

## 5 Special prompt

- In normal condition, it could not memory present testing value while not reaching impact times which has been set. If want to memory, press **【Cal. Average】** at the main display interface to end the testing in advance and then memory;

- When using the function of **【Cal. Average】** to end the testing in advance, the function of **【Auto Save】**、**【Auto Trans.】** etc. will not work;

- Not all hardness methods can be converted to each other for all materials(See table 1). The setting of hardness scale will recover to HL automatically after material setting is changed. So select **【Material】**first then select **【Hardness Scale】** when setting measure condition.

## 6 Operation explain in details

### 6.1 Switch on

Press  to switch on, the screen will show as follows in 2 seconds:

TIME<sup>®</sup> 5100  
TIME Group Inc.

Then it enters the main display interface, see figure 4.

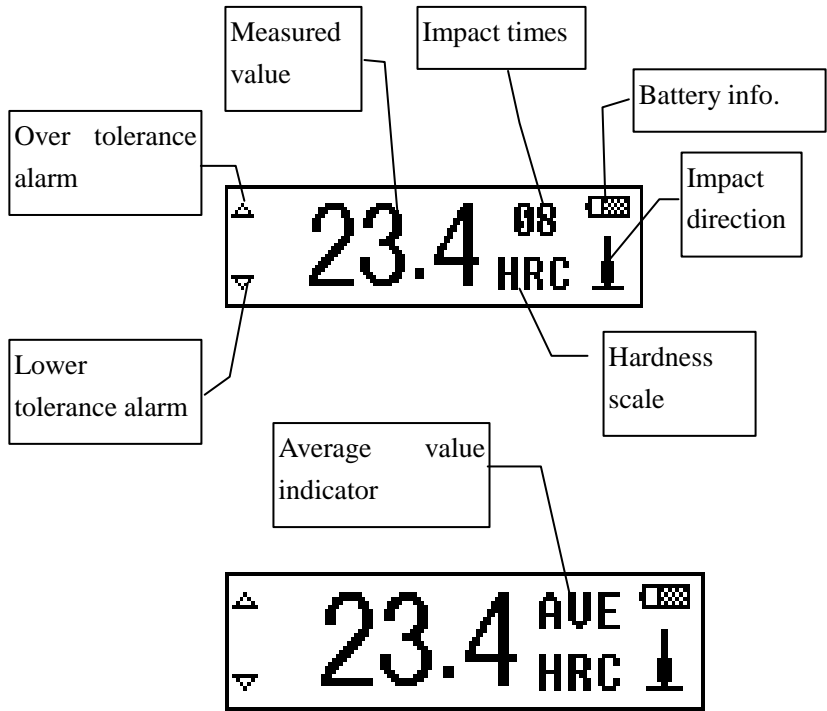

Figure 4



### **Instruction of the main display interface:**

**Measured value :** Display present single time measured value (without average value indicator), or display the present average value (with average value indicator).

Display ↑ means over conversion or measured range, ↓ means lower than conversion or measured range.



**Impact times :** Display the times that have been impacted, the according times will be displayed in reverse video when browsing single measured value.



**Average value indicator :** After reaching the preset impact times, It appears to show the mean value.

**Hardness scale :** Show the present hardness scale that has been selected.

**Impact direction :** Show the present impact direction that has been selected.

**Battery info :** Show the rest capacity of battery.



**Over tolerance alarm :** It will display as  when the present measured single value or average value is within the tolerance range, otherwise it will display as .

**Lower tolerance alarm :** It will display as  when the present measured single value or average value is within the tolerance range, otherwise it will display as .

### **6.2 Measuring operation**

The screen will display each measured value during each measurement under the measuring display interface, and the impact times add 1 accordingly; if the measured value is beyond tolerance range, the according mark will change to solid mark; the average value will be displayed in 2 seconds when reaching the impact times.

### 6.3 Key-press operation

- Press  or  to browse single measured value, the impact times will be displayed in reverse video;
- Press  to enter the menu.

### 6.4 Switch off

Press  to switch off.

### 6.5 Menu structure

Preset tester parameters and the additional functions can be performed by the menu operation. At the main display interface, press  to enter the main menu.

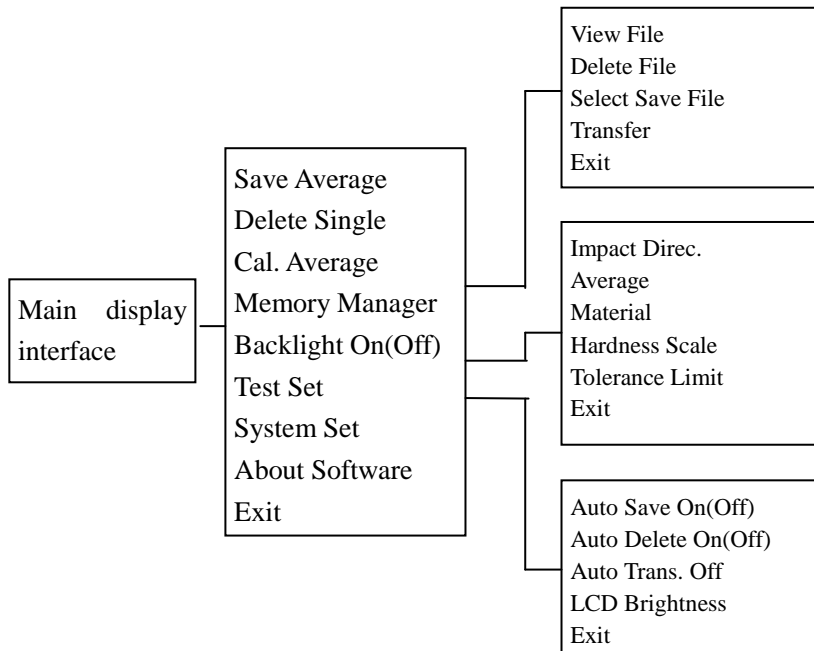







- For convenient operation, the common function such as “Save Average”、“Delete Single”、“Cal.

Average”、 “Backlight On(Off)”, have been put into main display interface;

- The main display interface have the key **【Exit】**, it is convenient to return to measuring display interface;

- Press **【Exit】** key will return to measuring display interface after using common function and setting function;

- Press  or  can choose all function and sub-menu circularly, press  to choose the underside function or sub-menu and then press  , the cursor will skip to the topside function or sub-menu, press  to choose the topside function or sub-menu and then press  , the cursor will skip to the underside function or sub-menu.

## 6.6 Common function

Press  to enter the main menu under measuring display interface.

## Save Average

Delete Single

Cal. Average

Memory Manager



Backlight On

Test Set

System Set

About Software

Exit

Press  or  to move the cursor to demanded function and  
press  to confirm.

*Note:* Press  or  
 to see pale letter.

**Save Average:** Memory the present average value.

**Note:** *The memory can not be processed under the both position of not reaching preset impact times and not choosing “Cal. Average”.*

**Delete Single:** Delete the last measured value; Delete the certain measured value when browsing the single measured value; Delete the last single measured value when displaying average value.

**Note:** *Please move the cursor to “YES” or “NO” and press  to confirm when delete.*

**Cal. Average:** Display the average measured value when impact times have not reached preset times.

**Backlight On(Off):** “Backlight On” will be displayed when choosing the backlight; “Backlight Off” will be displayed when not choosing the backlight.



**Note:** *Press any one of the keys  ,  ,  when switch on the backlight will be chose.*

## 6.7 Memory manager

The instrument includes 9 files and each one can memory 30 measured average value. You can choose another file to memory when 30 measured average value is stored,

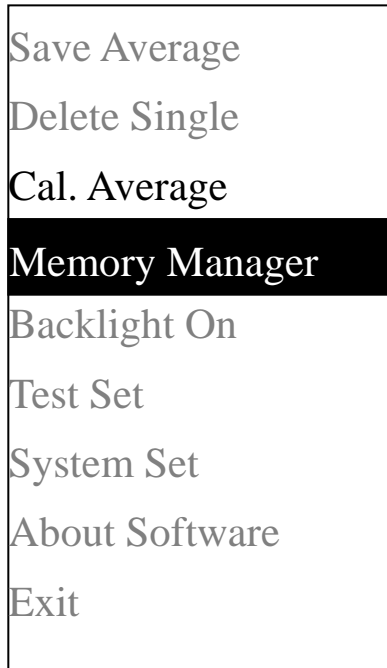

Press  to enter the main menu when on measuring display interface.



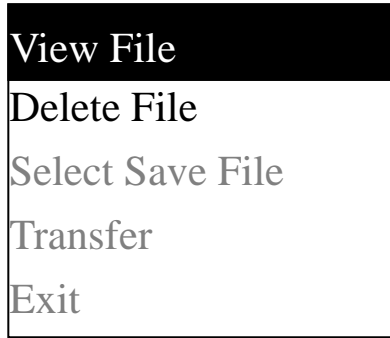

Press  ,  to move the cursor to **【Memory Manager】**,  
press  enter **【Memory Manager】** .

*Note : The pale letter can be seen by pressing  ,  .*



Press  ,  to move the cursor to certain function key and

press  .

*Note : The pale letter can be seen by pressing  ,  .*

### 6. 7. 1 Browsing file

Firstly please choose the file number to be browsed.



Press  ,  to choose the file number.

Press  to confirm.



No.01	789HL
No.02	517HL
No.03	788HL
No.04	522HL



Press  ,  to turn the page.

Press  return to **【Memory Manager】** .

### 6. 7. 2 Delete file

Firstly please choose the file number to be deleted.

File No. : <b>1</b>
---------------------

Press  ,  to choose the file number.

Press  enter confirm delete interface.

Confirm Delete
<b>YES</b> NO

Press  ,  to choose.

Press  to confirm and return to **【Memory Manager】** .

### 6. 7. 3 Memory file choosing

Choose the file number for memory.

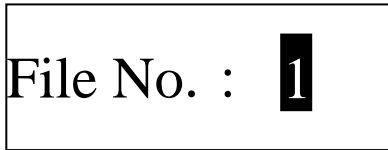

Press  ,  to choose the file number.

Press  to confirm and return to measuring display interface.



### 6. 7. 4 Data communication



The memory value can be transmitted out via USB interface, see 6.15.

### 6. 8 Test setting



Press  to enter the main menu under measuring display interface.

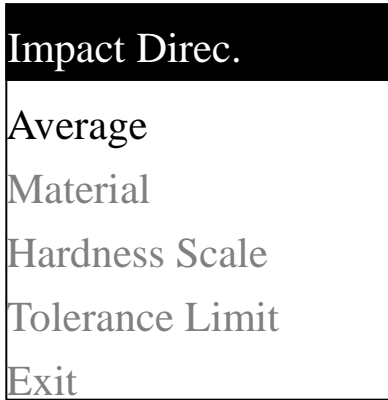

- Save Average
- Delete Single
- Cal. Average
- Memory Manager
- Backlight On
- Test Set**
- System Set
- About Software
- Exit

Press  ,  to move the cursor to **【Test Set】** and press  .

*Note: The pale letter can be seen by pressing  ,  .*





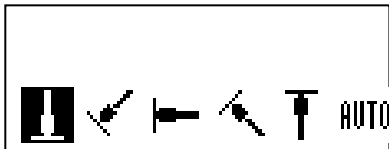

Press  ,  to move the cursor to certain function and press  .

*Note: The pale letter can be seen by pressing  ,  .*



### 6. 8. 1 Impact direction setting



Press  ,  to move the cursor to certain direction to be set.  
Press  to finish the set and return to measuring display interface.

If preset impact direction to **AUTO**, the instrument can identify the impact direction and correct the wrong direction automatically. Both directions of  and  are different and need to be confirmed by hand.



Press  ,  to move the cursor to correct impact direction.

Press  to confirm.

The indication of different direction displays is caused of shaking of impact device.

### 6. 8. 2 Mean times setting



The mean times can be modified from 1 to 10.

Press  ,  to modify.

Press  to finish set and return to measuring display interface.

### 6. 8. 3 Material setting

## (Cast) Steel

CWT. Steel

STAIN. Steel

GC. Iron



Nc.Iron

Cast Alumin

Copper-Zinc

Copper-Alumin

Wrought Copper

Press  ,  to move the cursor to certain material to be set.

Press  to finish set and return to measuring display interface.



*Note 1. The hardness scale will come back to HL after material setting.*

*2. Choose material firstly before choosing hardness scale.*

*3. The pale letter can be seen by pressing  , .*

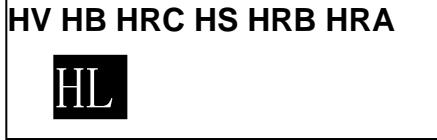
### 6. 8. 4 Hardness scale setting





Press  ,  to move the cursor to certain scale to be set.

Press  to finish and return to measuring display interface.

- Note :**
- 1. The hardness scales that displayed here only are corresponding to the choose material.*
  - 2. Choose material firstly before choosing hardness scale.*
  - 3. The hardness scale will come back to HL automatically after material setting.*

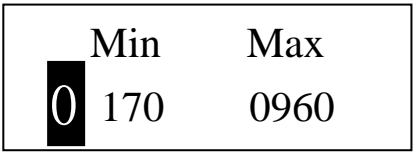
**6. 8. 5 Upper and lower limit setting**



Press  ,  to move the cursor to the position of figure.

Press  to move the cursor to next figure, the cursor will come back to measuring display interface when moving to the last figure.



*Note: 1.The instrument will remind you to reset the upper and lower limit when presetting is out of range.  
2.The lower and upper limit will reverse automatically when the lower setting is over the upper setting.*



## 6.9 System setting

Press  to enter the main menu under measuring display interface.





- Save Average
- Delete Single
- Cal. Average
- Memory Manager
- Backlight On
- Test Set
- System Set**
- About Software
- Exit

Press  ,  to move the cursor to **【System Set】** and press  .

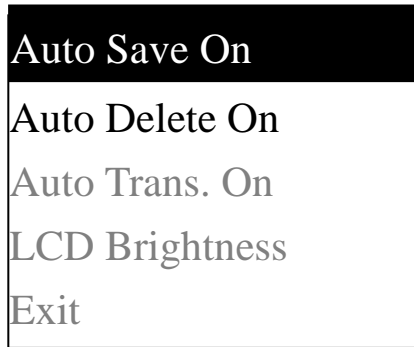
*Note: The pale letter can be seen by pressing*  ,  .



Press  ,  to move the cursor to certain function to be set

Press  to finish or enter into corresponding interface.

**Auto Save:** It stores the average value automatically after measuring and displaying average value. The “Auto Save On” displays when the function is turned off, and the “Auto Save Off” displays when the function is turned on.

**Auto Delete:** The “Auto Delete On” displays when the delete function is turned off, and the “Auto Delete Off” displays when the function is turned on.

**Auto Trans.:** The current group value can be transmitted out via USB port. For computer see 6.15. The “Auto Trans On” displays when the auto transmitting function is turned off, and the “Auto Trans Off” displays when the auto transmitting function is turned on.

### 6. 9. 1 LCD brightness setting

Bright: Press [  ]  
Dark: Press [  ]

Press  to add the brightness.

Press  to reduce the brightness.

Press  to finish and return to measuring display interface

*Note1、Bright means more brightness.*

*2、Dark means less brightness.*

### 6. 10 Software

Press  to enter into main menu under measuring display interface.

Save Average

Delete Single

Cal. Average



Memory Manager

Backlight On

About Software

System Set

Exit

Press  ,  to move the cursor to **【About Software】** and  
press  .

*Note : The pale letter can be seen by pressing  ,  .*

TIME 5100  
Version.: 1.0A  
Code: AG230110A  
SN: AG2304010001

This interface displays the information about instrument and software.  
No notification if there is any change with software version and mark.



Press  ,  to brows.

Press  to return to measuring display interface.

*Note : The pale letter can be seen by pressing  ,  .*

## 6. 11 Software calibration

The tester should be calibrated using standard test block before use this tester for the first time, or reuse after a long time.

Press  ,  and press  simultaneously, the tester is switched on and it enters the software calibration state.

Calibration  
0/5 Times

Preset the impact direction as  .  
Measure 5 points on the standard hardness block.

Average=550  
Nominal= 

It will display average value after measurement.

Press  ,  to input nominal value.

Press  to finish calibration.

Range of adjustment:  $\pm 15HL$ .

## 6. 12 Battery replacement

Battery replacement see figure 5.

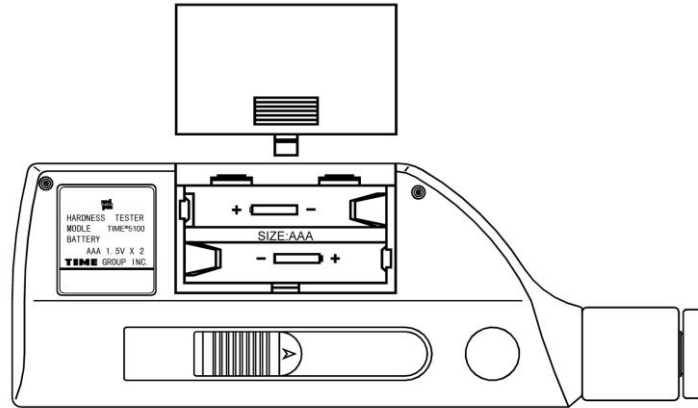



Figure 5

- When battery capability run out, the battery display symbol will glint as  , please replace battery as soon as possible.
- When replacing the battery the tester should be switch off firstly.
- Push out the battery cover, install 2 AAA (7#) 1.5V battery into the battery compartment according to correct direction.
- Push in the cover after installation of battery.

- The replacement of battery should be finished within 15 minutes, if beyond it the memory data may lost.
- Please collect the used battery avoiding pollution.

### 6.13 Backlight

The LCD screen has EL backlight. It is convenient to use in dark condition. Press any one of three keys



and press simultaneously, the backlight will be function on. Also the

backlight can be set under the main menu see 6.6.

### 6.14 Auto Power Off

- The tester has the function of auto power off to save the power of battery. If there is neither measurement nor any key operation within 5 minutes, the tester will shut off automatically.
- The screen will glint for 20 seconds before power off. Except  key, press any key to stop the twinkle of LCD screen and stop the operation of power off at the moment.
- While voltage of battery is too low, the tester will show < Battery Empty!>, then power off automatically.



## **6. 15 Connection of data transmission cable**

Insert one connection 4-pin plug of transmission cable into the USB socket on the side of the main unit, and insert the other plug into the USB socket in the back of computer box. The computer will display “TIME®510X Hardness Tester” founded.

After installation of driver program shipped with the tester, the driver program will imitate the hardness tester as equipment used in COM3 or COM4. The driver program can be found and its characteristics such as baud rate can be modified in “Equipment Manager” in computer. It can be displayed using “Super terminal” etc.

TIME software for PC has includes the driver program.

## **7 Maintenance and repair**

### **7. 1 Impact device**

- After the impact device is used for 1000--2000 times, use the cleaning brush provided to clean the guide tube and the impact body. To clean the guide tube, unscrew the support ring firstly, then take out the impact body, spin the cleaning brush in counter-clock direction into the bottom of guide tube and take it out for 5 times, and then install the impact body and support ring again.
- Release the impact body after use.
- Any lubricant is absolutely prohibited inside the impact device.

## 7.2 Repair

- When using standard Rockwell hardness block to test, if all the error is bigger than 2 HRC, maybe the test tip is invalid because of abrasion. Changing the test tip or impact object should be considered.
- When the hardness tester appears any other abnormal phenomena, please do not dismantle or adjust any fixedly assembled parts by yourself. You can contact with TIME Group Inc. service department.

## 8 Inspection periods

The inspection period of such hardness tester should not beyond one year. Users should arrange the inspection according to its own condition.

## 9 Notice for uses

- Non-guaranty parts:

Outside frame、battery、battery cover、display window、impact body ball、support rings.

## 10 Notice of transportation and storage

- Please keep it away from vibration, strong magnetic field, corrosive medium, dampness and dust.



## PORTABLE HARDNESS TESTER TIME®5100 PACKING LIST

No.	Description	Qt.	Note	No.	Description	Qt.
1	Main unit	1		13		
2	AAA battery 1.5V	2		14		
3	Small support ring	1		15		
4	Nylon brush	1		16		
5	Leeb hardness test block	1		17		
6	USB communication cable	1		18		
7	Driving disk for computer	1		19		
8	Instruction manual	1		20		
9	TIME certificate	1		21		
10	Warranty card	1		22		

11				23		
12				24		

# INTEGRATED HARDNESS TESTER

## TIME<sup>®</sup> 5100

# Instruction Manual

(V20120517)



**Beijing TIME High Technology Ltd.**

# CONTENTS

1 Introduction .....	1
2 Structure feature & testing principle.....	6
3 Specialties.....	7
4 Using .....	10
5 Special prompt.....	15
6 Operation explain in details.....	15
7 Maintenance and repair .....	41
8 Inspection periods.....	42
9 Notice for uses.....	42
10 Notice of transportation and storage.....	42